

# DESIGN GUIDELINES

*for* COUNTRY CLUB HISTORIC DISTRICT



DENVER LANDMARK PRESERVATION COMMISSION  
& PLANNING AND DEVELOPMENT OFFICE



CITY and COUNTY of DENVER  
MAY 1995

---

# T A B L E O F C O N T E N T S

<b>INTRODUCTION</b>	<b>1</b>
Designation of Country Club District	2
Types of Work Reviewed	3
Relationship to General Design Guidelines	3
<b>UNDERSTANDING COUNTRY CLUB HISTORIC DISTRICT AS A UNIQUE PLACE</b>	<b>3</b>
Historical Development	4
Context	5
Architectural Form	5
Urban Form	6
<b>DESIGN REVIEW ISSUES</b>	<b>8</b>
<b>DESIGN REVIEW GOALS</b>	<b>9</b>
<b>COUNTRY CLUB HISTORIC DISTRICT DESIGN GUIDELINES</b>	<b>11</b>
<b>A. PUBLIC SECTOR STREETScape GUIDELINES</b>	<b>11</b>
Parkways	11
Tree Lawns/Street Trees	11
Sidewalks	12
Street Lights	12
Gateways	13
<b>B. SITE PLAN GUIDELINES</b>	<b>14</b>
Front Setback of Primary Structure	14
Side Yard Setback of Primary Structure	14
Lot Coverage	15
Garages and Other Secondary Structures	15
Driveways	16
Walkways	16
Siting of Additions	16
<b>C. LANDSCAPE DESIGN</b>	<b>17</b>
Walls and Fences	17
Landscape Materials	17
Site Lighting	18
<b>D. BUILDING FORM, MASS &amp; SCALE</b>	<b>19</b>
Building Mass	19
Building Scale	19
Building Form	20
Roof Form	20
<b>E. MATERIALS</b>	<b>21</b>
Building Materials	21
Roof Materials	22
<b>F. ARCHITECTURAL DETAILS</b>	<b>22</b>
Porches and Entries	22
Doors and Entries	22
Windows	223
Ornamentation	24
<b>G. COLOR</b>	<b>24</b>

---

## COUNTRY CLUB HISTORIC DISTRICT DESIGN GUIDELINES

### INTRODUCTION

Two characteristics stand out as elements creating the special character of Country Club Historic District: the high quality of architectural design and construction of its substantial houses and the feeling of park-like spaciousness. The purpose of this document is to define the special characteristics of the district and to provide guidelines to help protect this character.

This document serves as an addendum to the *Design Guidelines for Landmark Structures and Districts* by addressing design review issues specific to the Country Club Historic District. The general guidelines document focuses on rehabilitation and alteration of historic structures. This document focuses on rehabilitation issues specific to the district by emphasizing certain guidelines; it in no way contradicts the general design guidelines. Furthermore, it provides additional guidance on the context of the district and new construction, specifically:

- ✓ How the streetscape and development pattern affects the relationship of structures to their surroundings and each other;
- ✓ How additions should relate to the structure itself, to other structures in the district, and to the street; and,
- ✓ How new infill or replacement structures should relate to other structures in the district, and to the street.

The combination of these district specific guidelines and the general design guidelines apply to all types of proposed alterations in Country Club. Rehabilitation of existing structures is covered primarily in the general design guidelines with some additional guidance provided in this document. New construction, both additions and infill structures, are dealt with in this document.



## DESIGNATION OF COUNTRY CLUB DISTRICT

Recognition of Country Club's significance was first made in 1979 when the western half of the district was listed in the National Register of Historic Places. The Country Club Historic District was designated as a Landmark District in 1990.

The L-shaped district includes 380 residences, most of which were constructed during the period of significance, 1902 through 1945. Country Club Historic District was found to qualify as a Landmark district because of its historical, architectural, and geographical significance.

✓ Historical significance relates to its association with Denver's social, political, and economic elite, including figures such as Mayor Robert Speer, founders of most of Denver's major banks, and heads of some of Denver's major mining, oil, sugar, and real estate companies. It also is representative of exclusive residential development of the time.

✓ The district incorporates some of Denver's finest examples of the Denver Square style and the Gothic, Colonial, Mediterranean, and other early 20th century eclectic revival styles. Furthermore, many of these houses were designed by Denver's most prominent architects including Fisher and Fisher, Benedict, Biscoe, Gove and Walsh, and Varian and Sterner.

✓ Geographic significance relates to the four different streetscape types found in the district, a degree of variety unique in Denver's historic residential areas.

### COUNTRY CLUB HISTORIC DISTRICT

National Register District Boundary - - - - -

Denver Landmark District Boundary —————



**TYPES OF WORK REVIEWED**

Designation as a Landmark District provides recognition to the area as being important to Denver’s historical identity and to maintaining high quality center city neighborhoods. It also provides protection in the form of design and demolition review by the Landmark Preservation Commission. As for all Denver Landmarks, any exterior alteration requiring a building, zoning, or other permit must be reviewed and approved by the Commission before the permit can be issued.

**RELATIONSHIP TO GENERAL GUIDELINES**

As stated above, these district guidelines serve as an addendum to the *Design Guidelines for Landmark Structures and Districts*. The matrix to the right summarizes which document or documents address various types of alterations. The general guidelines are organized into two sections, the first for all structures and the second for residential structures. The district guidelines may be more restrictive than the general design guidelines, but in no case are they contradictory or less restrictive. If a particular type of alteration is not addressed in the district guidelines, the general guidelines apply.

**UNDERSTANDING COUNTRY CLUB HISTORIC DISTRICT AS A UNIQUE PLACE**

Country Club Historic District, as the name suggests, was developed for Denver’s elite in conjunction with the Denver Country Club, which is located to the south of the district, across First Avenue. Generally, the layout of the streets and lots in the district is far more generous than the typical grid. It is the combination of different streetscape configurations combined with a range of early 20th century architectural styles that create the unique character of this district.

<b>LANDMARK AND COUNTRY CLUB DESIGN GUIDELINES BY TOPIC</b>			
	<b>Landmark Guidelines</b>		
	<b>General</b>	<b>Residential</b>	<b>Country Club</b>
Appropriateness of Use	XX		
Original Features			
Preservation	XX		
Replacement	XX		XX
Doors and Entrances	XX		XX
Windows	XX		XX
Treatment of Materials	XX		
Masonry	XX		XX
Roofs	XX		XX
Porches		XX	XX
Wood Details		XX	XX
Paint Color		XX	XX
Site Features	XX		XX
Fences & Site Walls	XX	XX	XX
Mechanical Equipment	XX		
Existing Alterations	XX		
New Alterations	XX		
New Additions			
Ground Level	XX		XX
Roof-Top		XX	
New Construction	XX		XX
Secondary Structures		XX	XX

---

## HISTORICAL DEVELOPMENT

In the first years of this century, a group of wealthy men who had organized the Overland Park Club changed the name to the Denver Country Club and began looking for a new site. In 1902, sale of 120 acres along Cherry Creek was made to the club, and the same day this group incorporated the Fourth Avenue Realty Company and purchased the land to the north.

The Fourth Avenue Realty Company chose William E. Fisher as its principal designer. Fisher designed landscaped parkways as the defining element of the area, basing the design on concepts espoused by Frederick Law Olmstead. Fisher also designed the Mediterranean gateways along Fourth Avenue, setting the tone for the other subdivisions included in the district.

Dates of the various additions that make up the Country Club Historic District are indicative of the pace of development. Park Club Place was filed in

two portions, the first in 1905 and the second in 1907. Country Club Place was filed in 1906. Country Club Annex, the area east of Country Club Place was amended between 1924 and 1927. Park Lane Square, the area to the north of Fourth Avenue, was filed in 1926.

Although Country Club Place was the first addition to be designed, Park Club Place was the first to receive development. The area generally developed from west to east with examples of early 20th century styles, primarily Denver Squares with elaborate detailing, concentrated in the western portion of the district and later examples of the revival styles, as well as newer structures to the east. Most of the development occurred in the 1910s and 1920s, with many of the houses being showcases for Denver architects of the period. The eastern half of the district began developing in the 1920s, but many of the lots remained vacant until after World War II.



View of Country Club Place, which is distinguished by its parkways.

---

## CONTEXT

Context has two components, architectural form and urban form. Architectural form is defined as the stylistic characteristics of the structures themselves. Urban form is the relationship of the structures to the street and to each other. In some districts, the urban form is constant and quite regimented, while in others, Country Club among them, urban form is more varied.

New construction must always be evaluated through comparison of the proposed new construction with the defining characteristics of a specific geographic area, either the district as a whole or a clearly defined portion of the district. Within the Country Club Historic District, the four subdistricts defined in the urban form section of this document will establish the context within which new construction is evaluated. Both the urban form and architectural form characteristics of each subdistrict will be used in the review of new construction.

**Architectural Form.** Country Club stands out as a district because of the number of large houses on large lots. Most of the historic structures are of two types: either Denver Squares (also called Foursquare) with elaborate revival detailing, or eclectic revivals with variations on the Colonial and Mediterranean styles being the most numerous; a few examples of large and small Bungalows can also be found.

Regardless of type, the houses have some common elements that are the basis of the districts architectural form. The houses are all fairly tall, tending to be one and one-half (1.5) or two (2) stories tall. Despite the height, a horizontal emphasis is created because of orientation and size. The structures all clearly consist of rectilinear volumes (squares, rectangles, and triangles) with applied elements and details. Roofs have two dominant characteristics: they are steeply pitched gable or hip roofs, and they are covered with tile, slate, or other material creating a strong texture. Brick and stucco are the most common materials, and masonry materials are used for details which are focused at entries, windows and roof lines. Broad expanses of wall and roof planes are broken with changes in plane and details to create a human scale, despite the size of the houses. Windows are punched, have a vertical emphasis, and have divided sashes or lights. Larger expanses of windows are created by groupings of smaller windows. Most of the Denver Squares have a porch and symmetrical placement of elements, while the eclectic revivals also have a strong entry statement but features are typically arranged asymmetrically.



One of the medians in Country Club Place.



View of Country Club, with its Denver Squares and traditional streetscape.

The houses tend to have both large lots and large footprints without being grandiose. A human, pedestrian-friendly scale is maintained with one-story features and ornament such as entries, bay windows, and story courses. Because of lot and house size, each house is viewed as an individual entity, rather than part of a broader context, so architectural form is of equal importance to urban form.

**Urban Form.** The urban form, the relationship of the structures to each other and the street, is more varied in Country Club than in most of the historic residential neighborhoods in Denver. The spaciousness of the district is its most unique urban form characteristic, created by the broad front and side setbacks and open front yards. The gracious character of the entire district is enhanced by the use of gateways on Fourth, Fifth, and Sixth avenues. The defining streetscape elements of tree lawn, sidewalk, and raised yard are found in only portions of the district.



Country Club Annex features houses in a variety of revival styles and traditional streetscape.

The Country Club Historic District includes four subdistricts dating to the early 20th century.

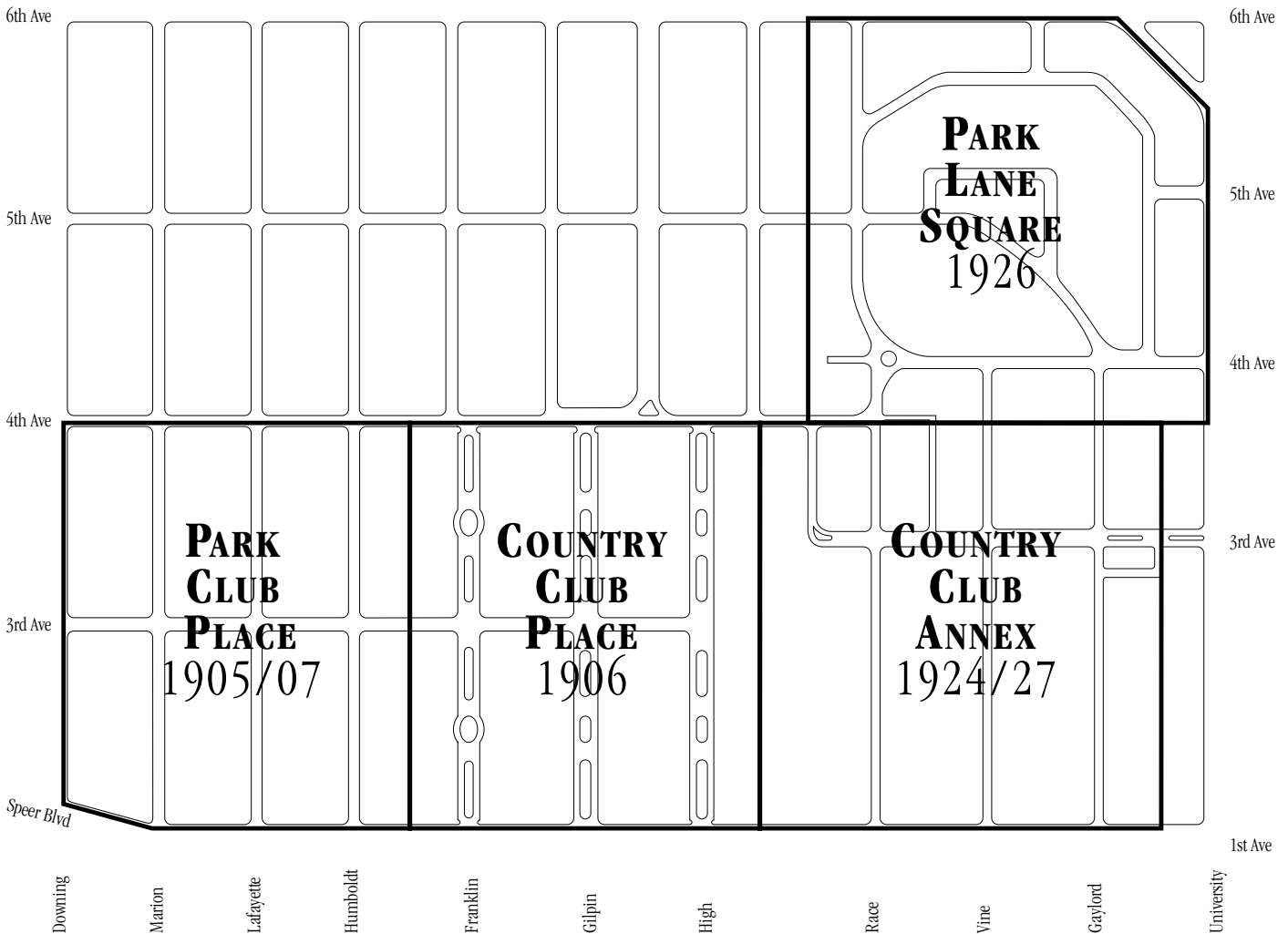

additions, each with its own combination of architectural form and urban form. Generally, however, the area can be divided into old Country Club and new Country Club, with old Country Club having three subareas. The older area is distinguished by the presence of tree lawns and detached sidewalks.

*Park Club Place*, identified by low brick gateways along Fourth Avenue, has streetscape character typical of most historic neighborhoods: tree lawns, detached sidewalks, raised front yards, and clearly defined entries. The houses tend to be as large as elsewhere in Country Club, but the lots are smaller so houses are closer together. Because of the varied styles of the houses, the alignment of architectural features (roofs, eaves, porches) is not a defining characteristic.

*Country Club Place* is the area designed by Fisher as the original Country Club addition. Large Mission style gateways are located along Fourth Avenue. This addition features parkways with landscaped medians in addition to the tree lawns and detached sidewalks. Large houses sit on large lots, and each house has a different siting, though front and side setbacks are generous. Because of this siting, each house is viewed within its own setting, with minimal relationship to adjacent structures.

*Country Club Annex* returns to a streetscape pattern similar to Park Club Place. The architectural form, however, is more like that of Country Club Place, with large houses on large lots. As a result the streetscape features align, but the architectural features do not. This is the only area that has no gateway features.

New Country Club, originally called *Park Lane Square*, features narrow curvilinear streets with no sidewalks. It is marked with brick gateways on its west, north, and east edges. The character of the subdistrict is established by the street layout and broad lawns. Most properties do not have fences or landscaping as defining features. Again, large houses on large lots give greater prominence to architectural form and character.



Three of the four subdivisions have gateways. Those of Park Club Place are most simple.



One of the Country Club Place gateways.

One of the large brick gateways of Park Lane Square.

Not all of the blocks in Country Club have alleys, so many residences have curb cuts for driveways. Historically, the garages (either attached or detached) were located at the rear of the property. Some newer structures have garages located closer to the front of the property.

Fences or retaining walls were also less prevalent in Country Club than elsewhere. Historically, many of the properties had a slope and some landscaping marking the front property line. The few fences were set back several feet from the sidewalk to create a landscape buffer. As a result of this pattern, the definition of public and private space was established with broad lawns, rather than site walls and fences.

### DESIGN REVIEW ISSUES

Design review issues identified by residents of the district and confirmed by review of design review applications focus primarily on the changing landscape character of Country Club. Specifically, these concerns relate to loss of the spaciousness that is so unique to this district.

✓ The first of the three major issues is loss of landscape features: landscaping has become overgrown obscuring the structures; many of the trees have been lost or are threatened by age or disease; and additions and new construction are eliminating existing landscaped areas.

✓ Second, many owners have installed security fences, which can diminish the spacious character and human scale of the district.

✓ Finally, new construction and large additions eliminate or reduce existing landscaped areas and create a more intense, urban character.

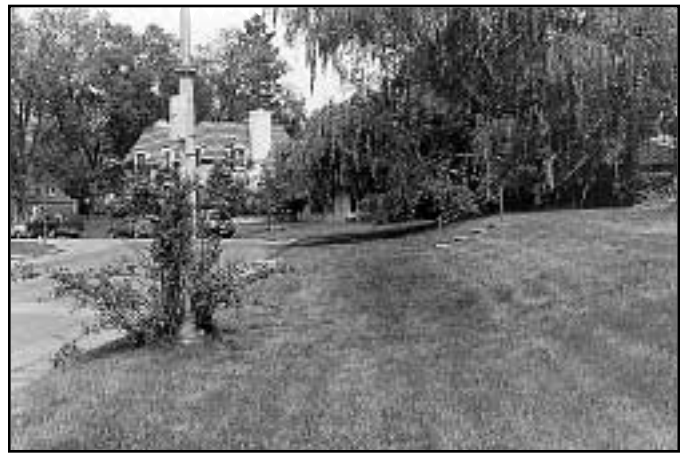

Park Lane Square has a rustic character with its curvilinear streets and lack of sidewalks.



Most of the Country Club District has streetscape features typical of Denver: treelawn, detached sidewalk, and raised front yard.

---

## DESIGN REVIEW GOALS

Design review goals are the guiding principles used in developing the specific guidelines. They represent the characteristics that need to be preserved if Country Club is to retain the sense of time and place portrayed in its application to become a Denver Landmark District.

*Preserve the integrity of the Country Club Historic District.* Any alteration should, at a minimum, perpetuate the ability to perceive the sense of time and place portrayed by the district.

*Preserve the integrity of contributing structures in the district.* Alterations to contributing buildings should be designed in such a way that the altered structure still contributes to the district.

*Maintain spaciousness, sense of living in a park.* Factors that contribute to this character include the broad front and side yard set backs and generous landscaping. The minimal use of fences and walls at the front property line also contribute to the spaciousness.

*Perpetuate the human scale of the district.* The sense of human scale attractive to pedestrians is created by large houses scaled with smaller details, breaks in roof and wall planes and the use of landscaping.

*To the extent possible, keep the broad front and side yard setbacks.* Country Club is distinguished by its large lots, which create broad front and side yards. The side yards are especially important to the sense of spaciousness. While property owners do have the ability to sell side yards of ample size (6,000 square feet as a minimum by zoning), such actions have a substantial impact on the character of the district.

*Maintain the variety of architectural styles and the tradition of architectural excellence.* New construction in the district should maintain the variety of architectural styles and types of detail found in the district, while reinforcing the common architectural characteristics including masonry materials, simple volumetric forms, pitch roofs, and textured roofing materials. New designs that reinterpret these traditional elements in creative ways are encouraged.

*Maintain relationship of mass to lot size.* Historically, the relationship of the structure to land has been a floor area ratio (FAR) of .30 (square feet of building divided by square feet of land). As additions and new larger structures are built, these ratios are changing. The 50 percent lot coverage allowed by



Abundant landscaping and broad lawns create a park-like setting.

zoning can permit structures with an FAR approaching 1.0 which is out of character for the district.

*Retain all contributing structures to the extent possible.* If noncontributing structures are replaced, the replacement structure should have no greater impact on the ability to sense the district's time and place than the original structure.

*Minimize the visual impact of garages and driveways.* The lack of alleys on some blocks and alley access onto busy First Avenue has necessitated curb cuts and driveways to access attached or detached garages. Regardless of access, garages and auto parking areas should be sited at the rear of the property. Additional curb cuts should be discouraged.

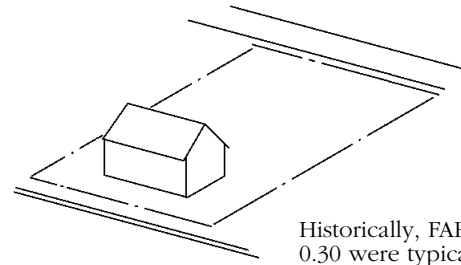

Historically, FARs of 0.30 were typical.



Some garages have been placed at the front of houses.

## COUNTRY CLUB HISTORIC DISTRICT DESIGN GUIDELINES

These district guidelines supplement the general guidelines referenced previously. The district guidelines are organized to address first urban form issues such as streetscape, landscape, and site design and then architectural form issues such as building shape and size, materials, and details. In all cases, new construction is evaluated on the basis of its compatibility with its context, which in the case of Country Club Historic District, is defined as the subdistrict in which new construction is located.

### A. PUBLIC SECTOR STREETScape GUIDELINES

#### Parkways

Parkways are the character-defining element of the Country Club Place sub-district. These informally defined parkways are located on Franklin, Gilpin, and High streets. On Franklin, the short sections are circles creating a bulb in the street.

- A1. Preserve historic parkways where they exist.** Respect the individual characteristics of each parkway, including its pattern, shape, and plant materials.

#### TREE LAWN / STREET TREES

Tree lawns, the band of grass between the street and sidewalk, are found in the subdistricts south of 4th Avenue. Historically tree lawns were planted with grass and street trees, which established a rhythm along the block and a sense of visual continuity. These tree lawns are distinctive features that reflect the historic platting plan for these portions of the neighborhood and should be preserved. Streetscaping, including tree lawns, are addressed in the general design guidelines and in the City and County of Denver's Streetscape Design Manual.

**A2. Preserve the historic character of tree lawns where they exist.**

- a. Maintain the soft, planted nature of the tree lawn. Limit the use of paving materials in this area to stepping stones that may lead from the curb to the sidewalk.
- b. Where street trees are a traditional feature, maintain them in good condition. When a tree must be removed, replace it with a similar species in a size that is sufficient to have a visual impact in its early years after planting.

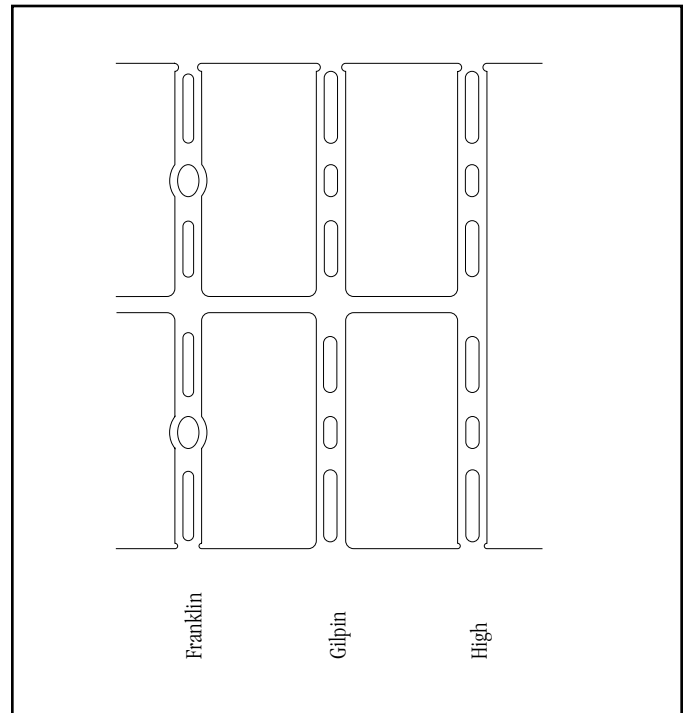

Country Club Place is distinguished by its parkways



Detached sidewalks and tree lawns are important features of much of the district.

---

## SIDEWALKS

The combination of tree lawn and detached concrete sidewalk is a defining characteristic of the subdistricts south of Fourth Avenue. Where sidewalks are a part of the heritage of the neighborhood, this tradition should be continued. Similarly, where sidewalks are not a part of the neighborhood's history, they should not be introduced.

### **A3. Preserve sidewalks where they exist.**

- a. Maintain sidewalks in good repair.
- b. If replacement is necessary, appropriate paving materials include concrete, modular pavers, brick and other masonry.

### **A4. Where a sidewalk exists, maintain its historic position, detached from the curb by a tree lawn.**

**A5. Sidewalks are inappropriate in locations where historically they were not used.** The lack of sidewalks in the Park Lane Square area should be retained.

## STREET LIGHTS

Street lights were not important elements of the original streetscape design throughout the Country Club historic district. In some cases, street lights have been added at later times. In most cases, these fixtures are relatively unobtrusive, so none of the types should set a precedent for any future lighting schemes. Since lighting was not a part of the district's history, any future scheme should include placement and fixtures that will not dramatically change the character of the district by day or night.

### **A6. Street lighting should minimize visual impacts on the district.**

- a. Designs that evoke an historic character outside the period of significance are inappropriate.
- b. If new street lighting is introduced, fixtures should be pedestrian in scale and subtle, unobtrusive, and contemporary in style.



In Park Lane Square, the lack of sidewalks is an important characteristic

---

## GATEWAYS

Monumental gateways define the entries to many of the blocks in the Country Club District. These entry markers are constructed in a variety of materials and styles. These gateways are significant district features that should be preserved. Additional gateway monuments should not be added.

### **A7. Preserve gateway monuments.**

- a. Repair gateway monuments when they are deteriorated.
- b. Where obscured by landscaping, prune or remove overgrown plants.
- c. Replace a gateway monument in kind if it is so deteriorated that it may not be repaired.



Three of Country Club's four subdistricts have Gateways. The Franklin Street Gateway is the largest and most elaborate.

## B. SITE PLAN GUIDELINES

One of the most distinctive features of the district is its sense of spaciousness. The large lots on which the houses sit result in broad open space along the streets and substantial side yards separating houses.

### FRONT SETBACK OF PRIMARY STRUCTURE

A variety in front setback from the street is found throughout the district. Within individual blocks, however, a fairly narrow range of setback widths is found. This generally uniform setback should be maintained.

#### B1. The front setback of a new structure should be in line with the median setback of historic properties on the block.

Setbacks of 20 feet to 30 feet or more are typical and are appropriate for new construction and additions.

- a. In general, larger, taller structures and taller portions of structures should be set back farther from the front than smaller structures.
- b. New structures should be sited to meet or exceed the median setback on the block face, not the structures with the least setback.

### SIDE YARD SETBACK OF PRIMARY STRUCTURE

#### B2. Side yard setbacks of a new structure or an addition should appear similar to those seen traditionally in the block.

In most of the district (Park Club Place excepted) lot sizes, and therefore side setbacks, vary considerably. In Park Club Place, most structures are on 50-foot-wide lots. Elsewhere, the width varies from 75 feet to a quarter block or more. In these areas, the minimum lot size of 6,000 square feet may not be adequate to reinforce the district's spacious character.

- a. Maintaining the sense of broad side yards is important to the character of the district. Additions and infill structures should be designed to maintain the perception of spaciousness by varying the setback of the structure along the side and varying the height of the structure.

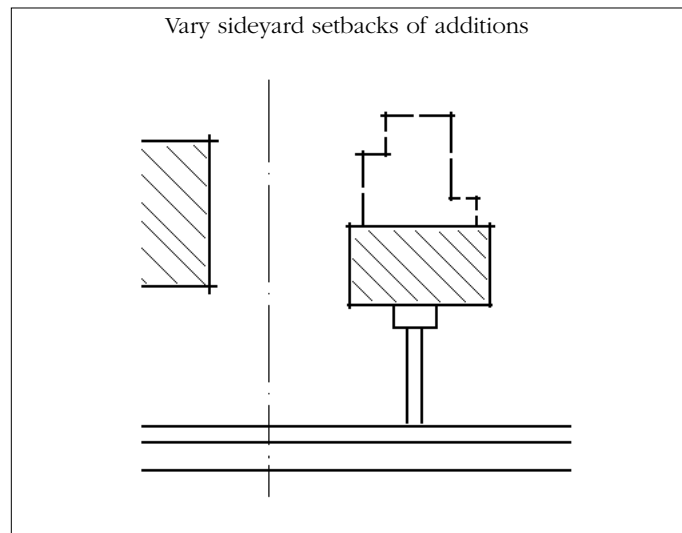
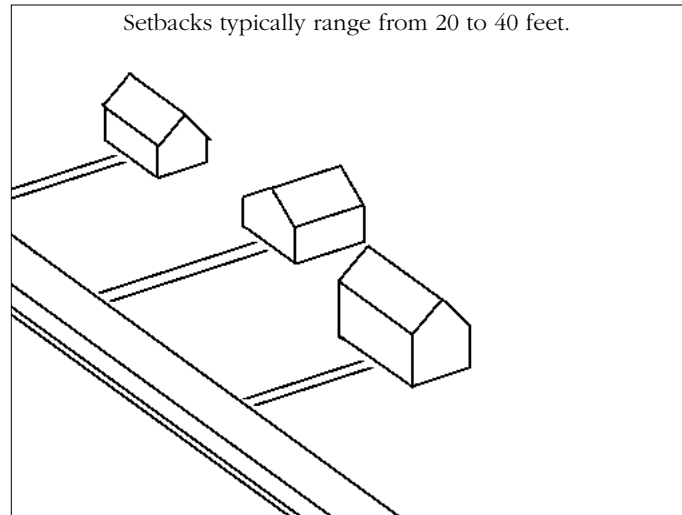

## LOT COVERAGE

Another factor contributing to the sense of spaciousness is the relatively low lot coverage of most residences.

### **B3. Maintain the traditional lot coverage ratio of the neighborhood.**

- a. Maintain the sense of spaciousness seen traditionally in the neighborhood by retaining significant portions of the site as open space.
- b. Historically, lot coverage ratios ranged from 18 to 30 percent, and FAR from .20 to .40. A lot coverage of less than 30 percent is recommended; although zoning allows 50 percent lot coverage. Over 30 percent lot coverage disrupts the character of the district by allowing FARs that approach 1.0.

## GARAGES AND OTHER SECONDARY STRUCTURES

Traditionally, secondary structures, such as garages and carriage houses, were subordinate to the primary structure on a lot. In many cases, these were detached buildings, located in the rear and accessed by an alley, if available. The tradition of detached secondary structures is encouraged because this reduces the overall perceived mass of building on the site.

### **B4. Garages and other secondary structures should remain subordinate to the primary structure.**

- a. Locating a secondary structure in the rear of the property is preferred.
  - b. A detached structure is also preferred.
- Whether attached or detached, a garage should be clearly subordinate to the primary structure and set back from the primary facade of the house.

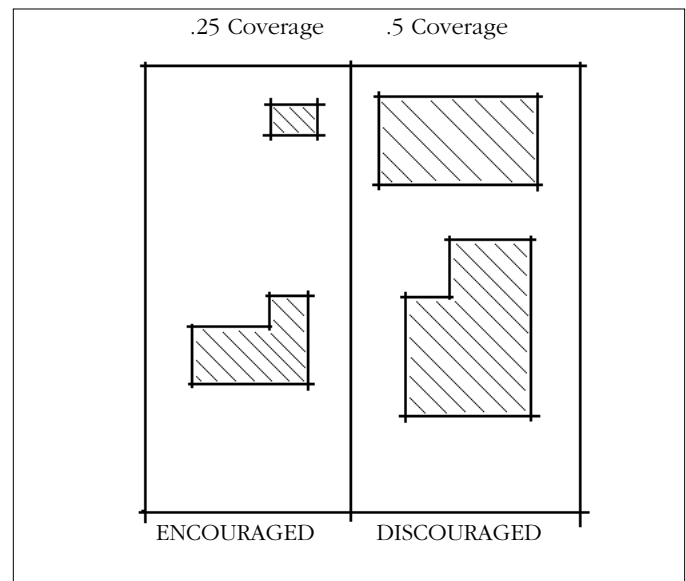

Where alleys exist, they should be used for auto access to garages.

**DRIVEWAYS**

**B5. Driveways should be visually subordinate in the site design.**

- a. Provide auto access from an alley, when feasible, to eliminate the need for a curb cut and driveway.
- b. Where a driveway is needed, minimize the visual impact of a curb cut. Only one curb cut per property should be allowed and any curb cut should be as narrow as possible.
- c. Minimize the amount of hard-surfaced driveway that is seen in the front yard.

**WALKWAYS**

Among the factors that contribute to the human, pedestrian scale of the district is the presence of walkways that lead from the sidewalk or street to a well defined entry at the front of the house. A variety of elements may be present along the walkway including steps, a gate, or sculptural elements. This progression of entry elements along a walkway is important to creating a clearly defined transition from public to private space.

**B6. Provide a walk to the building entry from the public sidewalk.**

- a. The sidewalk should be distinct from a driveway.
- b. Concrete is the dominant material; however, other materials, including brick, stone, or modular pavers also are appropriate.

**SITING OF ADDITIONS**

B7. Additions should be sited at the rear or side of a structure to minimize negative impact on important features of the site or structure. See the general guidelines for additional information.

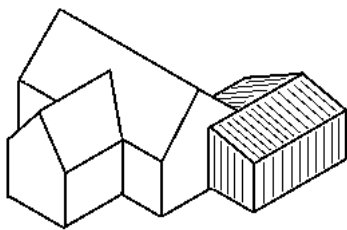

Set additions back from the front. Rear or rear-side are the preferred locations.

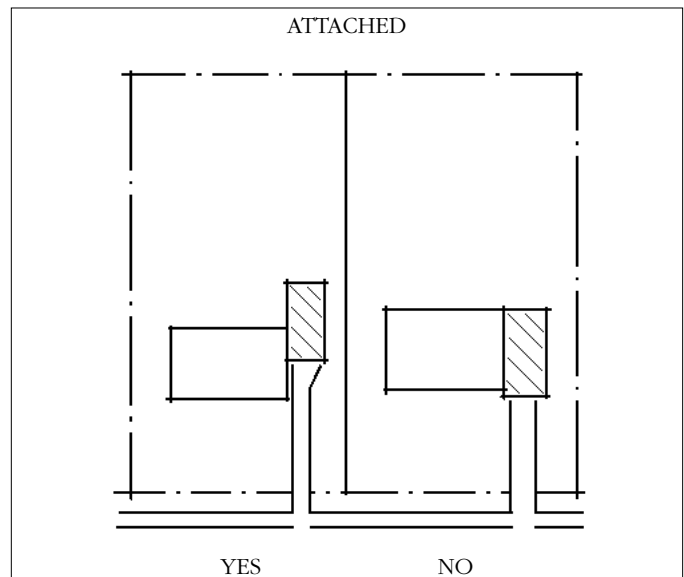
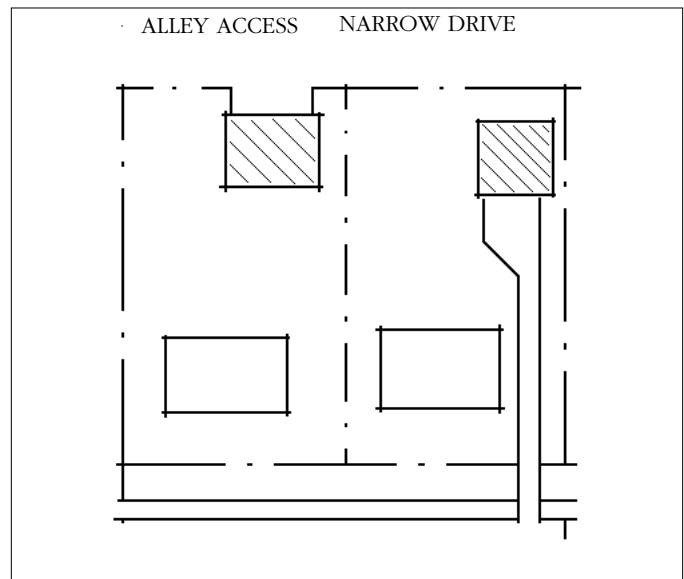
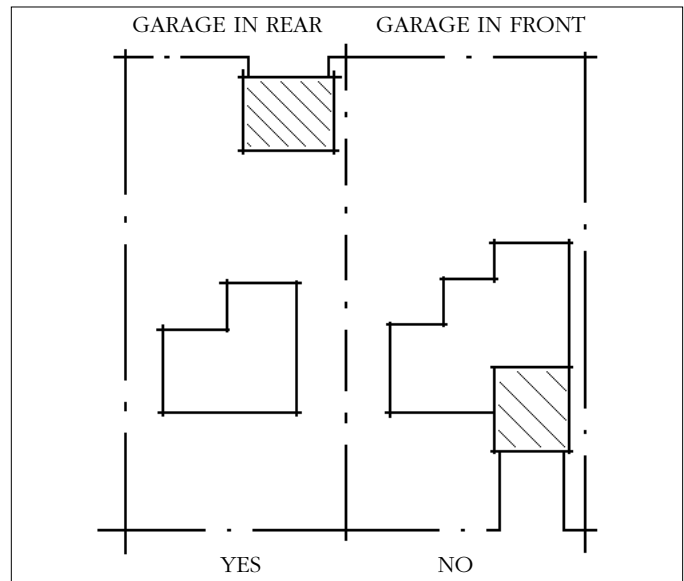

### C. LANDSCAPE DESIGN

These guidelines apply to areas of the site visible from the street, primarily front yards.

#### WALLS AND FENCES

Traditionally, front yards were open to the street. Few houses had walls or fences, so the effect of the broad front and side yards was enhanced. Over the years, fences and walls have been introduced to define property lines, provide security, or add decoration. Those walls and fences that do not detract from the district have several characteristics: they allow for views into the yard, have a landscape strip between the fence or wall and the sidewalk, and they are relatively low. In all cases, they are appropriate because they maintain a sense of openness in front yards.

Higher fences are typically used to define rear yards. Materials vary considerably. Fences seen from the street (corner lots) should be as carefully designed and meet the same guidelines as those at the front.

#### C1. If a fence is to be used in the front yard, it should be designed to allow views into the yard.

- a. A low fence or wall that allows views over it, or a fence that allows views through it, is appropriate in the front yard. Tall fences or walls, those in excess of 40 inches, are inappropriate in front yards.
- b. When feasible, set a fence back from the public sidewalk and provide plantings in front to soften the visual impact of the fence.

#### LANDSCAPE MATERIALS

#### C2. Use traditional plant materials in front yards and in tree lawns.

If desired, select drought-tolerant plants and ground covers that are more in character with those used traditionally. Cacti are among those plants that are not a part of this tradition.

#### C3. Consider traditional locations for plant beds, hedges, shrubs and trees.

- a. Traditionally, plantings were used at building foundations and as groupings to define spaces within the yard.
- b. Hedges were used to define side yard boundaries.
- c. Specimen trees were located throughout the grounds primarily to enframe views of the structure and to define activity areas.

#### C4. Masonry materials are appropriate for



Front yard fences are typically constructed of brick and wrought iron or wrought iron. In all cases, views into the front yard maintain the sense of spaciousness.

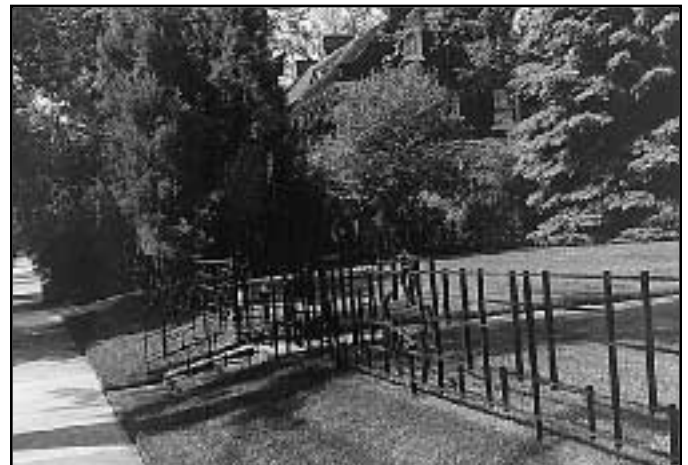

A planting strip between the sidewalk and fence softens the hard edge.



A variety of plants, shrubs, and trees serve different purposes. Hedges such as this define side yards.

---

**paving.**

a. Variety in paving materials is appropriate. Concrete is the dominant material; brick, sandstone and modular concrete pavers also are appropriate.

**C5. Landscape maintenance**

- a. Maintain landscape materials in good condition.
- b. Cut back overgrown plantings.
- c. Selectively remove trees and shrubs that are overgrown, old, or out of character, and replace as appropriate.

**SITE LIGHTING**

**C6. Minimize the visual impacts of site lighting.**

- a. Site lighting should be shielded, to avoid glare onto adjacent properties.
- b. Focus lights on walks and entries. Avoid lighting focused up at architectural elements of building walls.
- c. Fixture style should be in character with the structure.



Concrete is the most common paving material.

## D. BUILDING FORM, MASS & SCALE

Up to this point, the guidelines have addressed urban form issues. The guidelines that follow address architectural form of new construction, both infill structures and additions to existing structures.

Infill structures can be expected in three alternative locations: vacant lots, subdivided lots, and replacement for noncontributing structures. In Country Club, noncontributing structures are typically those constructed after the period of significance, 1902-1945, or not recognizable as having been built during the period of significance. Based on these definitions, the Commission will make a determination of contributing or noncontributing on a case by case basis.

### BUILDING MASS

#### D1. A new building should appear similar in mass to contributing structures in the district.

- Historically, most buildings ranged from 1.5 to 2 stories with 20 to 30 percent lot coverage. A new building should fit within this range.
- The primary ridge line of a structure rarely exceeds 40 feet.
- A single plane in the front facade rarely exceeds 50 feet in width. In many cases, the broad side of a house faces the street.

### BUILDING SCALE

Most houses have a height 1.5 or 2 stories. Despite the size of these houses, the scale is made human through use of one-story scaling elements such as porches, bay windows, and entries. Additionally, the raised foundation necessitates front stairs, which are another scaling element.

#### D2. A new building should appear similar in scale to those seen historically in the neighborhood.

- Front facades should appear similar in height to those seen historically in the block.
- Taller portions should be set back farther on the lot.
- Story heights should appear similar to those seen historically.
- Architectural details should be used to give a sense of scale.

*“New buildings should be compatible with their historic context, while also expressing contemporary interpretations of traditional building elements.”*

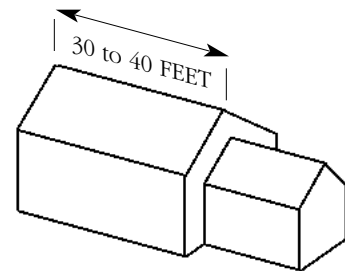

Ridge lines of historic structures rarely exceed 40 feet. Longer ridge lines or planes can disrupt the continuity of their district.



New structures should reinforce the mass, form and scale characteristics of the district.

## BUILDING FORM

Most structures were built as simple rectilinear volumes, to which ornament and detail of various revival styles were applied. Depending on the style, some are simple rectangles and triangles, with details applied; others are more complex forms composed of several rectangles. Free-form, domed or angular forms are not part of the building tradition in the district.

### D3. A new building should have a simple rectangular form as its basic shape.

- a. In most cases, the primary form for the house was a single rectangular volume. In some styles, smaller, subordinate masses were then attached to this primary form.
- b. Exotic building forms are inappropriate. Domed or A-frame structures, for example, would be out of character.

## ROOF FORM

Historically, steeply pitched roofs, either hip, gable, or occasionally gambrel, are prominent in the district. Roof pitches are steep with about 6/12 are typical. Broad overhangs or moldings that provide shadow lines at the eaves are also characteristic. In many cases, dormers break up the mass of a roof and add visual interest and a sense of scale. While many roofs are large planes, an uninterrupted ridge line rarely exceeds 40 feet in length. Tall chimneys with decorative brickwork at the top are a significant feature of most of the historic structures.

### D4. A new roof should appear similar in form to those of typical historic houses.

- a. Pitched roofs, either hip or gable, are preferred.
- b. Slopes should be within the range of those used historically, about 6/12.

### D5. A new roof should appear similar in scale to those of typical houses seen historically in the block.

- a. In general, a ridge line should not exceed 40 feet.
- b. Roof planes should be broken up with dormers and chimneys.

BUILDINGS ARE COMPOSED OF SIMPLE FORMS

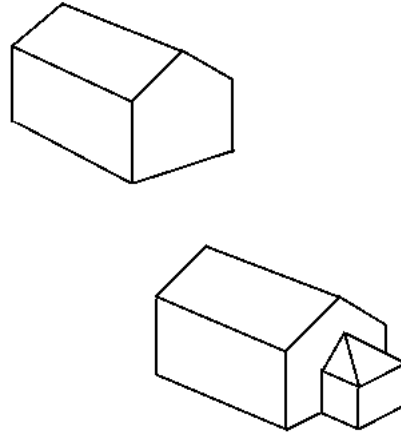

ROOF PITCHES ARE STEEP

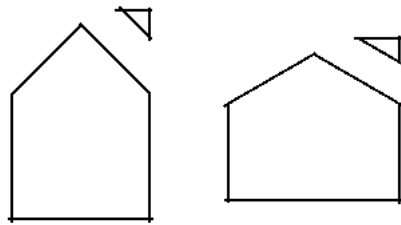

Although most of the houses are large, broad roof planes are broken by dormers, chimneys, and other projections.

---

## E. MATERIALS

### BUILDING MATERIALS

Historically, masonry building materials dominated the district. Brick of standard dimension, in a range of red, tan and ocher earth tones, was used most frequently. Mortar techniques varied widely. Stone and stucco also were used with some frequency. Wood was never used as a primary building material.

**E1. Building materials should appear similar to those used historically. Creative uses of traditional materials are encouraged in new construction.**

- a. Brick, in sizes and colors similar to those used historically, is preferred. Jumbo or over-sized brick is inappropriate.
- b. Stone, similar to that used historically, is appropriate. Using field stone or veneers applied with the bedding plane in a vertical position, is inappropriate.
- c. Stucco should appear similar to that used historically. Using panelized products in a manner that reveals large panel modules is inappropriate.
- d. Wood is appropriate as a secondary material for details and trim such as shingles and half-timber.
- e. In general, panelized and synthetic materials are inappropriate for primary structures. They may be considered on secondary buildings.

### ROOF MATERIALS

Use of textured roof materials such as slate, asphalt, or wood shingles, and tile are used on most contributing structures making this a defining characteristic. When roofing must be replaced, using a material similar to the original is preferred. On a new building, using a material similar in color and texture to those seen historically is encouraged.

**E2. Use roofing materials that are similar in appearance to those seen historically.**

- a. Slate, asphalt, tile, wood shingles are appropriate. Other materials such as metal shingles and concrete tiles may be appropriate if they convey a scale and texture similar to materials employed historically.
- b. Large panelized products, such as standing seam metal, should be avoided.
- c. Colors should be muted; the overall texture of a roof should be uniform and consistent throughout building.



Brick and stucco are the most common materials in the district.



Highly textured roof materials are a character defining feature of the district.

---

## F. ARCHITECTURAL DETAILS

Architectural details add interest to the street and help establish a human scale to buildings in the district. Where historic ornament and detail exists, it should be preserved. Contemporary interpretations of ornament and details are encouraged on new buildings.

### PORCHES AND ENTRIES

Clear definition of the front door is one of the most significant character-defining elements of structures in the district. Historically, the primary entrance to a house was identified by a porch, stoop or portico. Typically, these are one story in height and help establish a sense of scale to the block. In most cases, entries face the street. Even where the primary entrance is located to the side, its location is clearly marked with walkways and landscape elements.

#### **F1. Clearly define the primary entrance to the house.**

- a. Use a porch, stoop, portico or similar one-story feature to indicate the entry.
- b. Orienting the entry to the street is preferred.

#### **F2. The use of a primary entry door that is similar in scale to those seen historically is preferred. Avoid “grand” two-story entries with larger areas of glass.**



Porches, porticos, and other features clearly define primary entrances, which are a focus of detailing for the variety of revival styles found in Country Club.

## WINDOWS

Historic windows have several common characteristics regardless of the style of the house or specific type of window. Windows typically appear “punched” or inset into a solid wall plane. Window frames and sashes have substantial depth, creating significant shadow lines on the wall surface. Most windows have a vertical proportion. A horizontal band of windows is created by grouping smaller windows. While contemporary interpretations of traditional windows are encouraged, their basic, underlying scale and dimensions should appear similar to those seen historically.

### F3. Windows should appear similar in basic character to those seen traditionally.

- a. Windows that appear “punched” into the wall surface are appropriate.
- b. Window frames and sashes should have substantial depth.
- c. Windows that are vertically proportioned are preferred.
- d. To achieve larger areas of glass, group standard windows together.



Typically windows of historic houses are vertical. Groupings of windows such as this create a horizontal band.

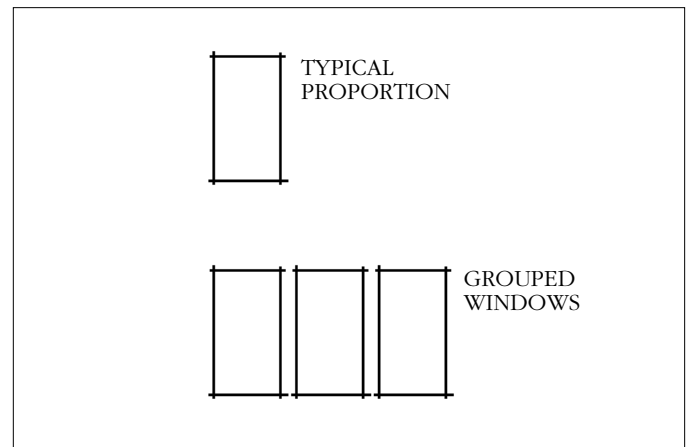

Vertically proportioned windows are typical of historic buildings.

#### **F4. Ornamentation**

The use of ornamentation on buildings is an established tradition in the district. In Country Club, most of the ornamentation is made of a masonry material such as stone, concrete, brick, or terra cotta. On new buildings, contemporary interpretations of building ornament and detail are appropriate, but not necessary.

Ornamentation is typically located around doors and windows, along eaves, and on porches, entries and gable ends. Major wall surfaces remain relatively simple.

#### **F4. The use of ornament and detail may be considered.**

- a.** Such details should have a substantial depth, and be constructed of durable materials.
- b.** While a range of materials is appropriate, details should have finishes that appear similar in finish to those used traditionally.
- c.** The details should appear integral to the overall design in scale, design, and material.

#### **G. COLOR**

In general, muted, earth-tone colors dominate the district. The intrinsic colors of masonry building materials establish the dominant palette. The lack of wood frame architectural detail eliminates the need to develop complex color palettes.

#### **G1. The dominant building colors should be muted earth tones intrinsic to the materials. Rely upon the integral color of the primary building materials.**



The large structures typical of the Country Club district have a variety of ornamental details to provide interest and human scale.



Colors intrinsic to masonry are most common. Brightly painted surfaces are not found in Country Club.

---

## BY AUTHORITY

ORDINANCE No. 448  
SERIES OF 1990

COUNCIL BILL No. 464  
COMMITTEE OF REFERENCE:  
Parks, Recreation

## A BILL

FOR AN ORDINANCE DESIGNATING THE COUNTRY CLUB DISTRICT AS A DISTRICT FOR PRESERVATION AND TO ADOPT DESIGN STANDARDS THEREFOR.

WHEREAS, the Preservation Commission has transmitted to the Council a proposed designation of a district for preservation; and

WHEREAS, the Planning Board has recommended approval of the same; and

WHEREAS, the district, has character, interest and value, as part of the development, heritage and cultural characteristics of the City; is identified with persons and groups of persons who had some influence on society; exemplifies the cultural, political, economic, social and historic heritage of the community; is the work of architects and master builders whose individual work has influenced the development of the City; is a distinctive area and should be preserved according to a plan based on its' historical and architectural motif;

NOW THEREFORE, BE IT ENACTED BY THE COUNCIL OF THE CITY AND COUNTY OF DENVER:

Section 1. That certain property described as follows, together with all improvements situated and located thereon, be and the same is hereby designated as a District for Preservation:

Beginning at a point at the intersection of the north right-of-way line of Speer Boulevard, extended, and the centerline of Downing Street; thence northerly along said centerline to the point of intersection with the centerline of East 4th Avenue; thence easterly along the centerline of East 4th Avenue to the point of intersection with the centerline of the alley located to the rear (east) of Lots 1-24, Block 15 and Lots 1-24, Block 25, Williams Driving Park Addition to the City of Denver; thence northerly along the centerline of said alley to the point of intersection with the centerline of East 6th Avenue; thence easterly along the centerline of East 6th Avenue to the point of intersection with the centerline of York Street; thence southeasterly along the centerline of York Street; to the point of intersection with the centerline of University Boulevard; thence southerly along the centerline of University Boulevard to the point of intersection with the centerline of East 3rd Avenue; thence westerly along the centerline of East 3rd Avenue to the point of intersection with the centerline of the alley located to the east of Lots 4-6, Block 6, Capital Annex, and Lot 33, Block 4, Country Club Annex Amended (Blocks 3 and 4); thence southerly along the centerline of said alley and said centerline extended, and continuing southerly along the rear (east) property line of Lots 1-32, Block 4, Country Club Annex Amended (Blocks 3 and 4) to the point of intersection with the north right-of-way line of East 1st Avenue; thence westerly along said north right-of-way line and continuing with the north right-of-way line of Speer Boulevard to the point of beginning; excluding the east 100 feet of Lots 1-4 and all of Lots 5 and the south 1/2 of Lot 6, Block 1, Capitol Annex, also known as PUD #235.

Section 2. Design Standards. Any building permit application to alter, construct, erect, add to or demolish any improvement situated in or located upon any real property described in Section 1 hereof shall be subject to architectural review by the Preservation Commission, as provided in Section 30-6 of the Revised Municipal Code, to determine the continuity, compatibility, appropriateness and relationship of the proposed alteration, construction, erection or demolition with adjacent buildings, the district as a whole and open spaces within the district. In such review the Commission shall consider, but with no necessity that the architectural style of existing buildings be reproduced, the following:

1. Height, in that new buildings, or modifications to existing buildings shall be of a height harmonious with the height of existing adjacent buildings;
2. The proportion and directional expression of the front facade;
3. The scale of building mass, units of construction and architectural details;
4. The position of buildings, street front facades, buildings entrances, and other walls and openings; and
5. The materials and texture of materials used in exterior construction.

Section 3. The effect of this designation may enhance the value of said property but may delay or require denial of building permits found unacceptable by the Preservation Commission under the criteria contained in Section 30-6(k) of the Revised Municipal Code and the design standards set forth therein.

Section 4. Severability. If any section, clause or phrase of this ordinance or its application to any person or circumstances is held invalid, such invalidity shall not effect other provisions or applications of the ordinance. The Council hereby declares that in these regards the provisions hereof are severable.

Passed by the Council: August 6, 1990 Cathy Donahue, President. Approved: Federico Peña, Mayor, August 8, 1990

Attest: Felisha Muftic, Clerk and Recorder, Ex-Officio Clerk of the City and County of Denver. Published in the Daily Journal, August 3, 1990 / August 10, 1990. Prepared by: Landmark Preservation Commission, July 24, 1990. Reviewed by: Patricia Wiler, City Attorney, July 7, 1990.



C I T Y   *a n d*   C O U N T Y   *o f*   D E N V E R

Approved for Legality:

Approved and Adopted:

Robert M. Kelly   Date 5/16/95  
Robert M. Kelly  
Assistant City Attorney for the City and County of Denver

Sharon R. Nunnally   Date 5/16/95  
Sharon R. Nunnally  
Chair, Landmark Preservation Commission

*Adopted and published pursuant to  
Section 30-6 of the Revised Municipal Code of the City and County of Denver  
and Article VI of Chapter 2 of the Revised Municipal Code of the City and County of Denver.*

---

A C K N O W L E D G M E N T S

**WELLINGTON E. WEBB**

Mayor

**JENNIFER T. MOULTON**

Director, Planning and Development Office

**DENVER LANDMARK PRESERVATION COMMISSION**

Sharon Nunnally, Chair  
Phillip E. Flores, FASLA  
Barbara Sudler Hornby  
Stephen J. Leonard, Ph.D.  
Barbara Norgren  
Seth Rosenman, AIA  
Roz Schneider  
B. Story Swett, AIA  
Edward D. White, Jr., AIA

**COUNTRY CLUB DESIGN REVIEW SUBCOMMITTEE**

Edward D. White, Jr., Chair  
Kathy Borgen  
Dave Dutton  
Kathleen Economos  
Mona Ferrugia  
Bob Fuller  
Rosanne Hall  
William Wenk

**CREDITS**

**PLANNING AND DEVELOPMENT OFFICE**

Ellen T. Ittelson, Senior City Planner  
Mark Hess, Graphic Designer

**CONSULTANT**

Nore Winter, Winter & Company

**FUNDING**

Colorado Historical Society, State Historical Fund  
City and County of Denver

**PHOTOGRAPHY**

Ellen T. Ittelson